

Bridge Rectifier Diode 整流桥

■ Features 特点

Glass passivated chip junction 玻璃钝化结
High surge current capability 高浪涌电流能力
Peak Soak Temperature 260°C 峰值浸润温度 260 度
Package 封装: DB-S

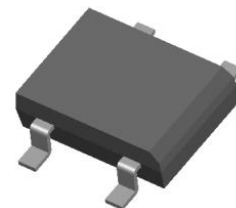
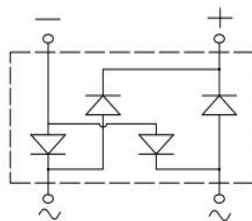

■ Maximum Rating 最大额定值

($T_A=25^{\circ}\text{C}$ unless otherwise noted 如无特殊说明, 温度为 25°C)

Characteristic 特性参数	Symbol 符号	DB301S	DB302S	DB303S	DB304S	DB305S	DB306S	DB307S	Unit 单位
Peak Reverse Voltage 反向峰值电压	V_{RRM}	50	100	200	400	600	800	1000	V
DC Reverse Voltage 直流反向电压	$V_{R(DC)}$	50	100	200	400	600	800	1000	V
RMS Reverse Voltage 反向电压均方根值	$V_{R(RMS)}$	35	70	140	280	420	560	700	V
Forward Rectified Current 正向整流电流	I_F	3							A
Peak Surge Current 峰值浪涌电流	I_{FSM}	80							A
Thermal Resistance J-A 结到环境热阻	$R_{\theta JA}$	30							$^{\circ}\text{C}/\text{W}$
Junction and Storage Temperature 结温和储藏温度	T_J, T_{stg}	150 $^{\circ}\text{C}$, -65to+150 $^{\circ}\text{C}$							

■ Electrical Characteristics 电特性

($T_A=25^{\circ}\text{C}$ unless otherwise noted 如无特殊说明, 温度为 25°C)

Characteristic 特性参数	Symbol 符号	Min 最小值	Typ 典型值	Max 最大值	Unit 单位	Condition 条件
Forward Voltage 正向电压	V_F		1.1		V	$I_F=3\text{A}$
Reverse Current ($T_A=25^{\circ}\text{C}$) 反向电流($T_A=125^{\circ}\text{C}$)	I_R			5 500	μA	$V_R=V_{RRM}$
Diode Capacitance 二极管电容	C_D		19		pF	$V_R=4\text{V}, f=1\text{MHz}$

■ Typical Characteristic Curve 典型特性曲线

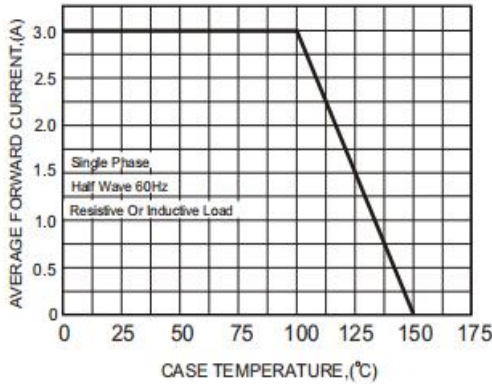

Figure 1: Forward Current Derating Curve

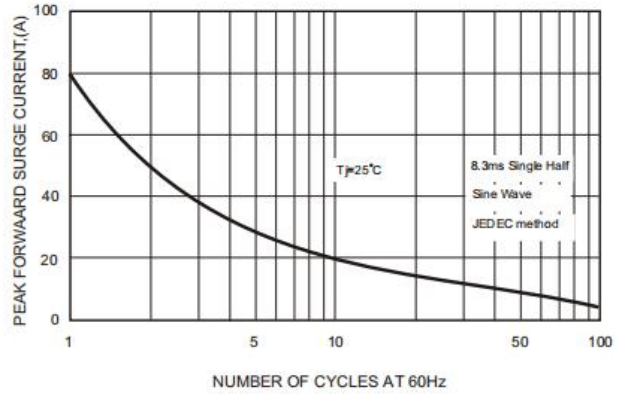

Figure 2: Peak Forward Surge Current

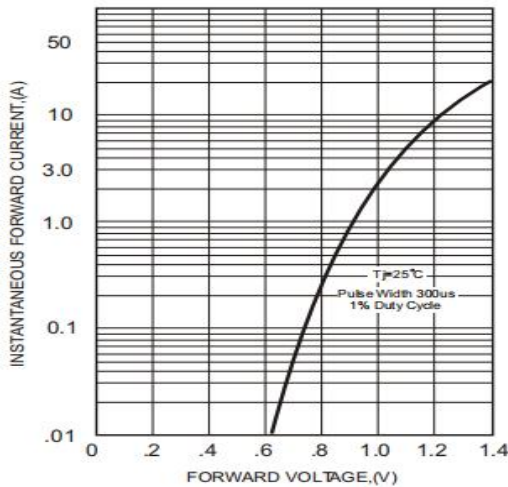

Figure 3: Instantaneous Forward Characteristics

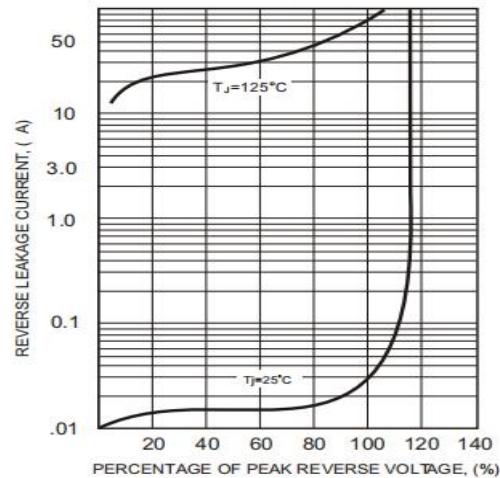
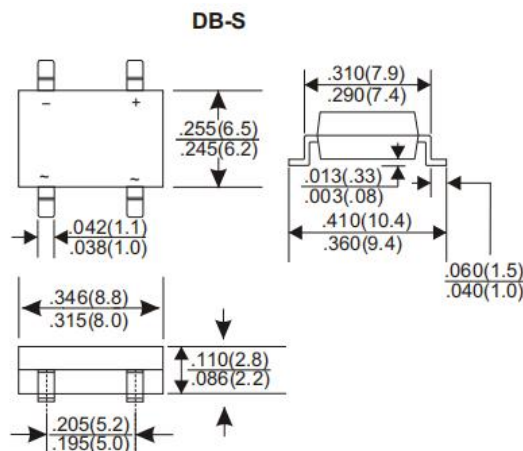

Figure 4: Reverse Leakage Characteristics

■ Dimension 外形封装尺寸



Dimensions in inches and (millimeters)