

SMC Fast Recovery Diode 快恢复二极管

■ **Features 特点**

Built-in strain relief 内应力释放
Fast Recovery time 快恢复时间
Surface mount device 表面贴装器件
Case 封装:SMC

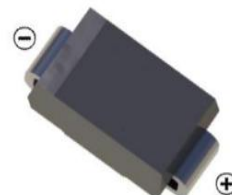

■ **Maximum Rating 最大额定值**

($T_A=25^{\circ}\text{C}$ unless otherwise noted 如无特殊说明, 温度为 25°C)

Characteristic 特性参数	Symbol 符号	RS 3AC	RS 3BC	RS 3DC	RS 3GC	RS 3JC	RS 3KC	RS 3MC	Unit 单位
Repetitive Peak Reverse Voltage 重复峰值反向电压	V_{RRM}	50	100	200	400	600	800	1000	V
DC Reverse Voltage 直流反向电压	V_R	50	100	200	400	600	800	1000	V
RMS Reverse Voltage 反向电压均方根值	$V_{R(RMS)}$	35	70	140	280	420	560	700	V
Forward Rectified Current 正向整流电流	I_F	3							A
Peak Surge Current 峰值浪涌电流	I_{FSM}	100							A
Thermal Resistance J-A 结到环境热阻	$R_{\theta JA}$	25							$^{\circ}\text{C}/\text{W}$
Junction/Storage Temperature 结温/储藏温度	T_J, T_{stg}	-50to+150 $^{\circ}\text{C}$							$^{\circ}\text{C}$

■ **Electrical Characteristics 电特性**

($T_A=25^{\circ}\text{C}$ unless otherwise noted 如无特殊说明, 温度为 25°C)

Characteristic 特性参数	Symbol 符号	RS3AC-RS3GC	RS3JC	RS3KC-RS3MC	Unit 单位	Condition 条件
Forward Voltage 正向电压	V_F	1.3			V	$I_F=3\text{A}$
Reverse Current 反向电流	I_R	10($T_A=25^{\circ}\text{C}$) 350($T_A=125^{\circ}\text{C}$)			μA	$V_R=V_{RRM}$
Reverse Recovery Time 反向恢复时间	T_{rr}	150	250	500	nS	$I_F=0.5\text{A}, I_R=1\text{A}$ $I_{rr}=0.25\text{A}$
Junction Capacitance 结电容	C_J	60			pF	$V_R=4\text{V}, f=1\text{MHz}$

■ Typical Characteristic Curve 典型特性曲线

FIG.1-TYPICAL FORWARD CHARACTERISTICS

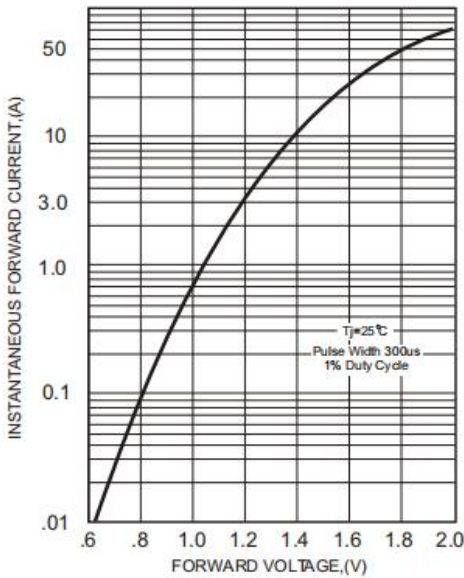

FIG.2-TYPICAL FORWARD CURRENT DERATING CURVE

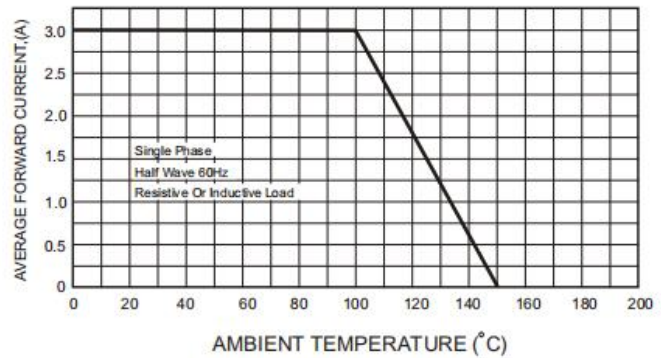

FIG.4-MAXIMUM NON-REPETITIVE FORWARD SURGE CURRENT

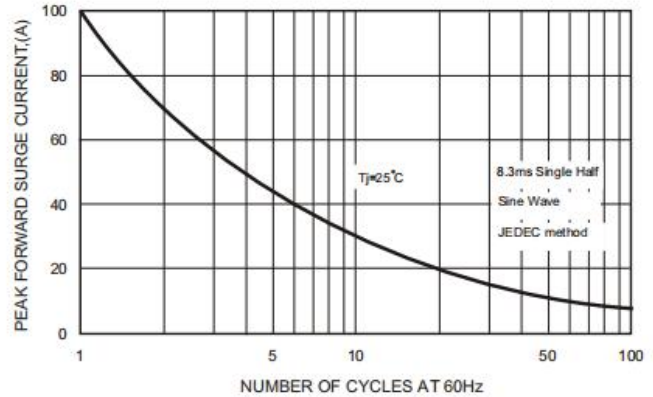
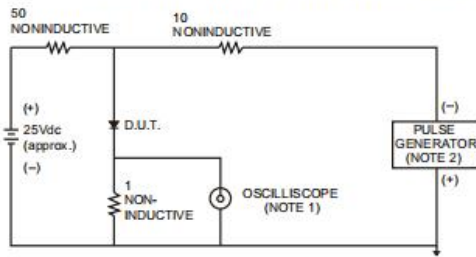

FIG.3- TEST CIRCUIT DIAGRAM AND REVERSE RECOVERY TIME CHARACTERISTICS



NOTES: 1. Rise Time= 7ns max., Input Impedance= 1 megohm, 22pF.
2. Rise Time= 10ns max., Source Impedance= 50 ohms.

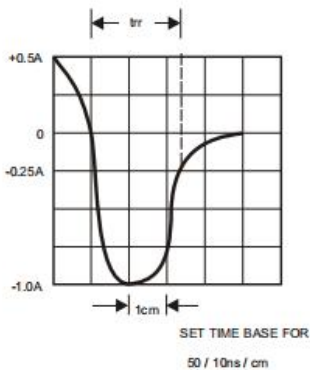
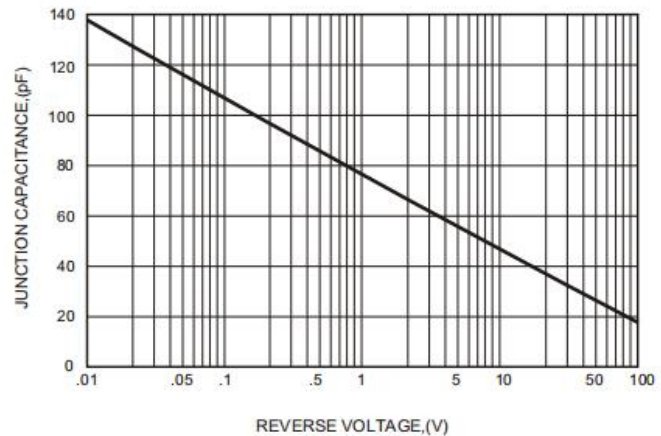
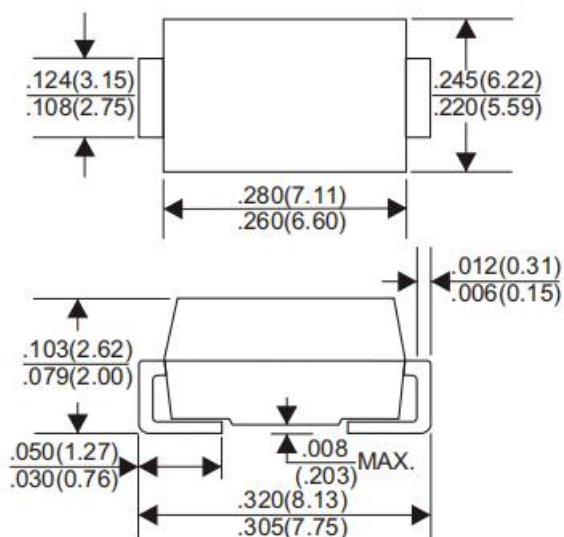

FIG.5-TYPICAL JUNCTION CAPACITANCE



■Dimension 外形封装尺寸

DO-214AB(SMC)



Dimensions in inches and (millimeters)